



Cura II, Cura II Extra High & Cura II Supreme

Community bed frames

User Manual

Issue 23/04/2026

UBEB7001. UBEB7001EH. UBEB7001S.UM-15



Contents

1.	Introduction.....	4
2.	Intended Use.....	5
3.	Product Description.....	6
	3.1 Model variations.....	6
4.	Symbols and Statements.....	7
5.	Safe Use Guidelines.....	8
	5.1 Safety information – nursing personnel, carers and users.....	8
	5.2 Safety information – bed assembly.....	9
	5.3 Safety information – maintenance and inspection.....	10
6.	Environmental Conditions.....	11
7.	Installation and Set-Up.....	12
	7.1 Assembling the bed.....	12
	7.2 Before using the bed.....	15
8.	Handset Control.....	16
	8.1 10-button handset.....	16
9.	Bed Adjustments.....	17
	9.1 Knee-break section adjustment.....	17
	9.2 Manual calf section adjustment.....	17
	9.3 Backrest section adjustment.....	18
	9.4 Bed height adjustment.....	18
	9.5 Auto-contour adjustment.....	18
	9.6 Trendelenburg and Reverse Trendelenburg.....	19
10	Moving the Bed.....	19
11	Selecting a Mattress.....	20
12	Extending the Bed.....	20
	12.1 To extend the bed frame.....	20
	12.2 To extend the platform.....	20
13	Accessories.....	22
	13.1 Attaching Grab Rail to the bed.....	22
	13.1.1 Attaching the standard grab rail to the bed.....	23
	13.1.2 In line Grab Rail.....	23
	13.1.3 Daily Checks on Grab Rail.....	23
	13.2 Attaching 3/4 Side Rails to the bed.....	24
	13.3 Attaching Full Length Telescopic Side Rails to the bed.....	25
	13.3.1 Operating the Full Length Telescopic Side Rails.....	26
	13.3.2 Daily Checks on Side Rail.....	30

13.4	Lifting poles	30
13.5	Mattress squab.....	30
13.6	Side rail bumpers.....	30
13.7	Mesh full length side rail bumpers.....	31
13.8	Attaching mesh full length rail bumper extension	31
14.	Transport and Storage.....	33
14.1	Disconnecting the controller.....	33
14.2	Dismantling the bed	33
14.3	Storing the bed	34
15.	Cleaning and Disinfection	34
15.1	Cleaning	34
15.2	Disinfection.....	34
16	Maintenance and Inspection.....	35
16.1	Maintenance – daily.....	35
17	Trouble Shooting	36
18	Reuse.....	37
19	Disposal.....	37
20	Expected Service Life.....	38
21	Specifications	38
21.1	Bed data	38
21.2	Electrical data.....	39
22	Warranty.....	40
22.1	Product warranty	40
22.2	Conditions of warranty.....	40
22.3	The following are excluded from the warranty	40
22.4	How to make a claim	41
22.5	General.....	41
23	Example of risk assessment.....	42

1. Introduction

This User Manual contains instructions for the installation, use and maintenance of the Ultimate Healthcare Cura II, Cura II Extra High and Cura II Supreme beds.

The bed described in this User Manual is constructed to the following standards:

- *EN 60601-2-52:2010*

This operating manual will familiarise you with the functions of the bed and in addition describes:

- How to set up the bed
- How to operate the adjustment controls
- How to look after and maintain the bed



Caution: Ultimate Healthcare shall not be liable for any damage or injury caused by failure to follow the proper instructions as described in this User Manual.



Caution: Before using the bed all staff must familiarise themselves thoroughly with the various parts and controls as detailed in this User Manual.

This User Manual has been drawn up using information available at the time of printing with regard to the design and operation of the bed.

We reserve the right to make changes due to technical improvements.

If you have any questions regarding the bed, please contact Ultimate Healthcare (contact details are provided on back cover).

Note: Ultimate Healthcare reserves the right to modify the information in this User Manual at any time. The information in this User Manual may vary slightly with respect to the basic design of the product.

2. Intended Use

The bed is intended to support patients using the moveable sections as and if required within the following environments:

- Nursing home
- Home

This bed must not be used for any other purpose than that which it is intended, for example it must not be used as a standing platform. It is for indoor use only.

The bed is compliant to BS EN 60601-2-52:2010+A1:2015 and not suitable for children and adults with an atypical anatomy (physical size less than 146 cm, mass less than 40kg or a body mass index of less than 17). A review and individual risk assessment must be completed for all end users and on atypical anatomy as priority by putting measures to reduce such entrapment risks.

Before using the bed and any accessories in combination, a risk assessment should be performed. Please refer to 'Example of risk assessment in section 23' of this manual. This should include but should not be limited to:

- The risk of trapping or pinching
- The risk of the patient slipping between mattress and the side rails / Grab rails and any other accessories used with the bed
- Unintended operation of the bed
- Any limitation of the patient's ability to operate the bed

Thoroughly read the entire User Manual prior to setting up and using the bed.

Ensure that:

- The entire User Manual is read by all persons entrusted with the setting up, operation or maintenance of the bed.
- All persons entrusted with the setting up, operation or maintenance of the bed have access to this User Manual at all times.

Any damage resulting from non-observance of this User Manual is excluded from the warranty.

The illustrations contained in this User Manual show examples of how to handle the Ultimate Healthcare beds and may differ from your particular model.

3. Product Description

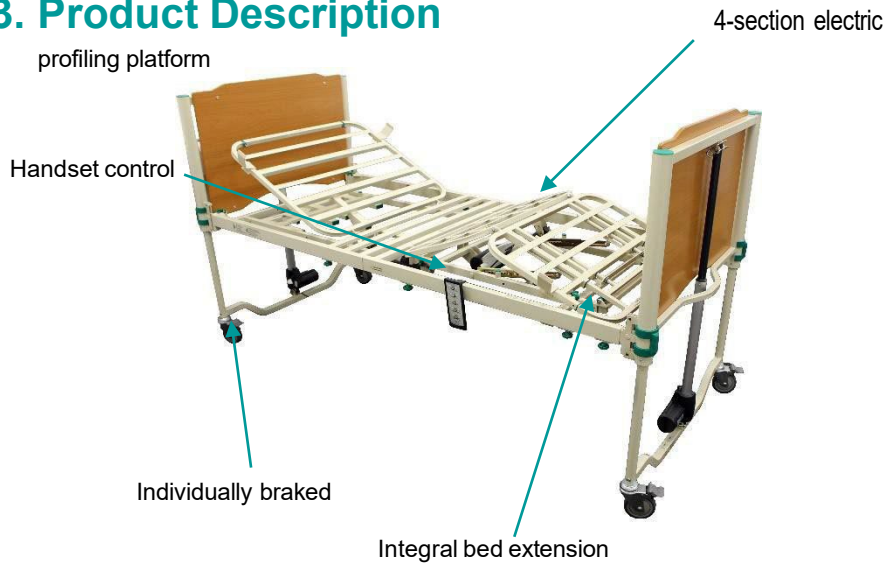

Note: The above illustration is for reference purposes only. The specification of your actual Cura II bed may vary to the above illustration.

- 4-section electric profiling with variable height control and adjustment
- Active auto-regression profiling reduces shear and friction in sacral area (*selected models only*)
- Integral bed extension of 200mm
- Reverse Trendelenburg - variable tilt positioning
- Handset control features a fob lockout
- Transport brackets attach to the bed to help prevent loss
- Maximum user weight 215kg (34 stone) – Safe working load 250kg (39.5 Stone)
- Accessories – please see *Accessories Section 13* in this Manual.

a. Model variations

Cura II (10-button handset)	Cura II Extra High (9-button handset)	Cura II Supreme (10-button handset)
Bed raise/lower function	Bed raise/lower function	Bed raise/lower function
		Auto-regression
Lock-out function	Lock-out function	Lock-out function
Reverse Trendelenburg	Reverse Trendelenburg	Reverse Trendelenburg
Trendelenburg		Trendelenburg
(Optional) Battery back-up (retro-fit possible)	(Optional) Battery back-up (retro-fit possible)	(Optional) Battery back-up (retro-fit possible)



Note: Fitting of accessories must be made in conjunction with the User Instructions supplied with the accessory.



Note: The fitting of accessories may present additional risks to Users and suitable precautions should be taken.

4. Symbols and Statements

This User Manual contains the following symbols which are used to show you specific risks when dealing with the product or information on how to simplify handling.



Caution: This symbol indicates the need for the user to consult the instructions for use for important cautionary information such as warnings and precautions that cannot, for a variety of reasons, be presented on the medical device itself.

Symbols used in this manual and on the Cura II, Cura II Extra High and Cura II Supreme community bed:



B symbol, indicates this product is according to degree of protection against electric shock for type B equipment.



Caution, read the instructions before use.

IPX6

Level of Ingress Protection type against water



Disposal of electrical and electronic equipment (WEEE): This product should be handed over to an applicable collection point for the recycling of electrical and electronic equipment.



CE certification in accordance with 93/42/EEC.



Protection class II (Protective insulation).

Note: Maximum continuous operation of the actuator motors is 2 minutes at maximum load; it must then be followed by a period of rest for 18 minutes, before being activated again.

5. Safe Use Guidelines

The bed is fitted with a locking handset; which is achieved via a locking fob; individual functions may be locked out.



Caution: When using any equipment that is positioned under the bed such as Mobile Hoists, ensure there is no risk of entrapment, pinching of cables or risk of damage to motors or actuators when the bed is moved to its lowest settings.



Caution: Although this bed has been designed to be used with the common types of portable hoists care should be exercised when using this bed with all portable hoists. The user must ensure that sufficient clearance is afforded to all hoist legs, masts and booms and that cables of the bed and hoist are not trapped, snagged, kinked or pinched when operating the bed or the hoist.

5.1 Safety information – nursing personnel, carers and users



Caution: Risk of Accidents!

- Do not use electrical medical appliances on patients in these beds involving intravascular or intra-cardiac connection.
- Do not use the bed in the vicinity of strong electromagnetic fields.
- Always plug the bed mains plug into a separate wall socket. Do not use a multi-plug adaptor.
- Route the mains cable to the wall socket in such a way that there is no mechanical tension, and the mains cable cannot be pinched, kinked or run over.
- When routing cables from other equipment within the bed, precautions should be taken to avoid squeezing those parts of the bed.
- Please observe the respective equipment operating and assembly instructions with regard to any additional safety risks that may arise when using the bed in conjunction with other equipment. If you have any questions, please contact Ultimate Healthcare (see details on the back cover).
- Always risk assess the beds including accessories to medical, environment conditions of the end user.



Warning: Danger to life and risk of injury due to trapping/pinching/damage!

- When carrying out adjustments, watch the occupant in the bed and the bed's surroundings. **Ensure no visitor or non-service user is on the bed.**
- Grab rails (UBEB7004/UBEB7004-3) can be used on both the upper and lower brackets.
- When the bed is on the highest bracket setting all Ultimate Healthcare side can be used.
- When the bed is on the lowest bracket setting only use the extra high full length (UBEB7002FL-4) or ¾ length rails (UBEB7002). Standard height full length rails (UBEB700FL-2) should not be used on the lower bracket setting.
- Ensure that the side rails are properly locked in place.
- When lowering the bed, make sure that there are no obstructions under the bed; pay particular attention to the feet of the person operating the bed and those of any other person in attendance.
- **IMPORTANT** - Always perform a risk assessment of the bed, mattress and accessories to avoid entrapment, refer to section 13 (Accessories) on page 22.



Warning: Possible danger to life due to alteration of the patient's position

- Always lock/disable all handset adjustment functions which could cause danger to the patient's health if adjusted. Consult doctor.
- Always take account of the patient's condition and risk assess when locking/disabling the adjustment options.



Warning: Accident hazard due to falling out of the bed!

- The bed should always be left in its lowest position when the patient is unsupervised or for the patient to get in or out of the bed in order to reduce the risk of injury due to falls.



Caution: Risk of short circuit and fire

- Before moving the bed, disconnect the mains plug and secure the mains cable from being run over.
- Do not use the bed in surroundings in which flammable gases or vapors may be present.



Caution: Danger due to actuator motor overheating!

- Before adjusting the bed height, ensure that nothing is blocking the full adjustment movement.
- Avoid operating the actuator motors continuously for more than two minutes.
- Maximum continuous operation of the actuator motors is 2 minutes. The minimum pause after 2 minutes operation is 18 minutes.
- Never use more than two actuator motors simultaneously.
- Ensure there is nothing preventing the actuator from working correctly, a mattress incorrectly secured to the bed frame can prevent the backrest or knee break from functioning correctly and causing damage to the patient or the bed.

5.2 Safety information bed assembly



Warning: Risk of Injury due to incorrect assembly!

- Ensure that all bed components are correctly assembled.
- Check that all adjustment options are in perfect working order after assembly,



Caution: Risk of Accidents!

- Only perform assembly work using suitable tools.
- Only perform the work described if you are familiar with handling the required tools.

5.3 Safety information – maintenance and inspection

Only allow maintenance and inspection work to be carried out by or under the supervision and guidance of trained expert personnel who, on the basis of their specialist training, knowledge and experience - in addition to knowledge of all the relevant regulations - are capable of evaluating the condition of the bed and of recognising any possible effects and hazards.

Always read the relevant chapters of this User Manual thoroughly before carrying out maintenance and inspection work.

Any damage resulting from non-observance of this User Manual is excluded from any liability of the manufacturer.



Caution

- Always carry out a function test following maintenance work and inspections.
- When operating the actuator motors, ensure that the bed cabling cannot be pinched, overstretched or kinked.



Caution: Hazards due to electrical and mechanical faults!

- Immediately remove faulty/defective beds from operation and secure them against unauthorised use. Disconnect the mains plug from the wall socket.
- Only use original spare parts from Ultimate Healthcare.
- Always carry out the prescribed maintenance and inspection work at the specified intervals, see *Section 16 Maintenance and Inspection*.
- Do not carry out any alterations to the electrical or mechanical fittings supplied with the bed unless authorised to do so by the manufacturer. Unauthorised alterations lead to any liability of the manufacturer becoming null and void.
- Only perform maintenance and inspection work using suitable tools.
- Do not open electrical components.

6. Environmental Conditions

	Min	Max
Operating temperature range	10°C	40°C
Relative Humidity (RH)	10%	60%
Altitude range (above mean sea level)	0m	3,000m

The IP (liquid and dust ingress) rating for the control module on the Cura II, Cura II Extra High and Cura II Supreme medical beds is IPX6. The Cura II, Cura II Extra High and Cura II Supreme beds are designed for medical purposes only. Electrical installations must comply with your local electrical installation requirements.

7. Installation and Set-Up

a. Assembling the bed

Remove packaging; all cardboard is recyclable; carefully dispose of all plastic packaging to avoid risk of suffocation; recycle plastics where facilities exist.



Caution: Read these instructions carefully before attempting to assemble the bed.

1. The bed will be secured on transport brackets (*figure 1*) with the motors on the head and foot section facing inwards. Before attempting to remove any parts of the bed off of the transport brackets ensure that the brakes are engaged on the castors. These must be foot operated only.
2. Ensure all elevating sections of the bed are secured to the frame, to prevent entrapment injury.
3. Carefully remove the foot section from the transport bracket and place it motor side down on the floor (*figure 2*)
4. Repeat step 3 with the head section.
5. Remove the slider bars from the transport brackets.
6. Rotate the locking collar (*figure 3*) and carefully remove the bed end from the transport bracket; allowing the remaining bed end to lean against a wall. Remove the transport bracket from the second bed end and put to one side.

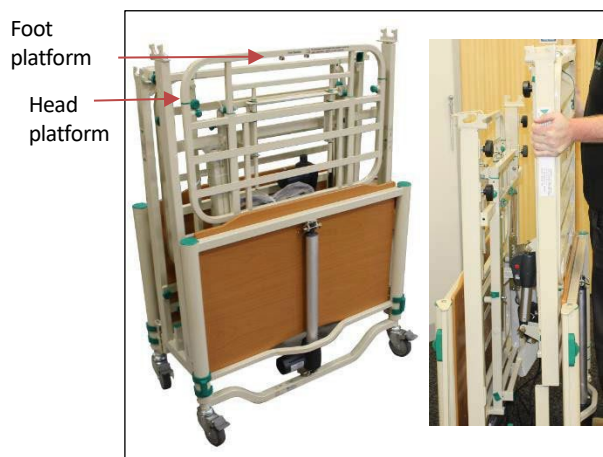

Figure 1: Bed on transport brackets



Figure 2: Foot section motor side down



Figure 3: Unlocking locking collar side down

7. Lift the head platform section onto the head section (*figure 4*) and clip into the bracket. Ensuring that the head platform section is fully clipped in place.
8. Repeat step 6 with the foot platform.
9. Rotate the locking collar (*figure 5*) to secure the head platform section in place, repeat on other side. Cut the cable tie which is holding the actuator to the head section, flip the actuator and attach to the frame using the c-clip (*figure 6*).

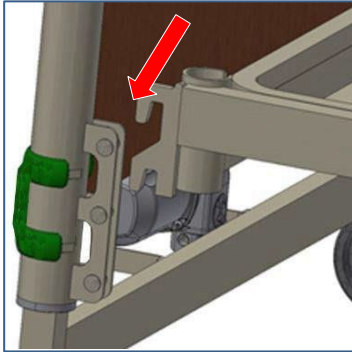

Figure 4: Foot section attachment to bed end



Figure 5: Collar locked



Figure 6: Head section actuator



Whether choosing the lower or high brackets ensure the bed platform is clipped into the same level of bracket on all four legs.

10. Slide the sliders into the end of the head platform section (*figure 7*) and secure with a hand screw, repeat on other side.
11. Carefully align the two sections of the bed and slide together (*figure 8*). Tighten the turn screw to secure then carefully place the bed onto its side to connect the controller.

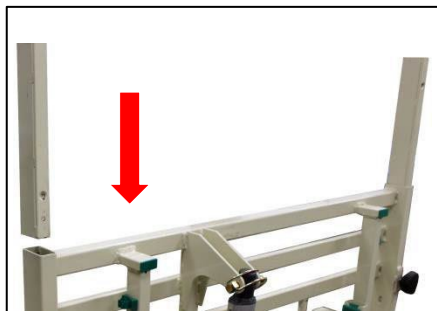
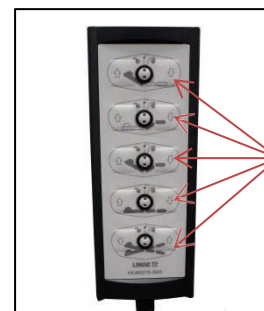

Figure 7: Foot section attachment to bed end



Figure 8: Connecting platform sections



Press each button (on both sides)

Figure 9: Test each function on the handset

Connecting the controller:

- Connect cable 2 from the control box to the foot end actuator
- Connect cable 2 from the control box to the headend actuator
- Connect cable 1 to the backrest actuator
- Plug the mains plug into the wall socket and make sure all of the cables are secured in the cable retaining clips.

12. The transport brackets can be safely stored under the bed frame to prevent loss of the brackets. This can either be done whilst the bed is on its side or by raising the bed to its full height and attaching them underneath. The transport brackets can then be attached

to the fixing points onto the underside of the bed as indicated (figure 10). Ensure each bracket is locked in place by securing with a turn screw.

13. Careful place the bed back onto its wheels and unpack handset and test functions (figure 9), by default the Trendelenburg function is locked out.



If when operating the handset the functions operate incorrectly it may be that the cables are located in the wrong actuators. The bed will have to be carefully turned over again and the cables will have to be inserted into the correct actuator points. The bed will then have to be carefully put back onto its wheels and tested again to make sure the handset operates the correct parts of the bedframe.

14. Attach the 4 mattress retaining clips over the hole on the bed frame (figure 11).
15. See (figure 12) to see the location of where the mattress retaining clips should be fitted on the bed frame and where the secure tags can be found. Be sure to fit the retainer bar to the foot end of the bed (figure 13)

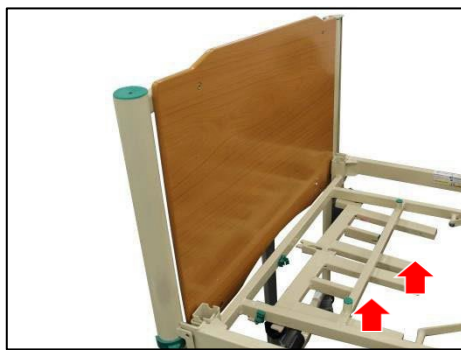

Figure 10: Storing transport brackets

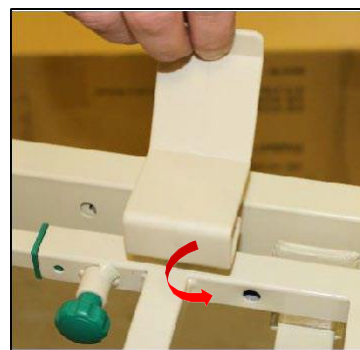

Figure 11: Mattress retaining clip

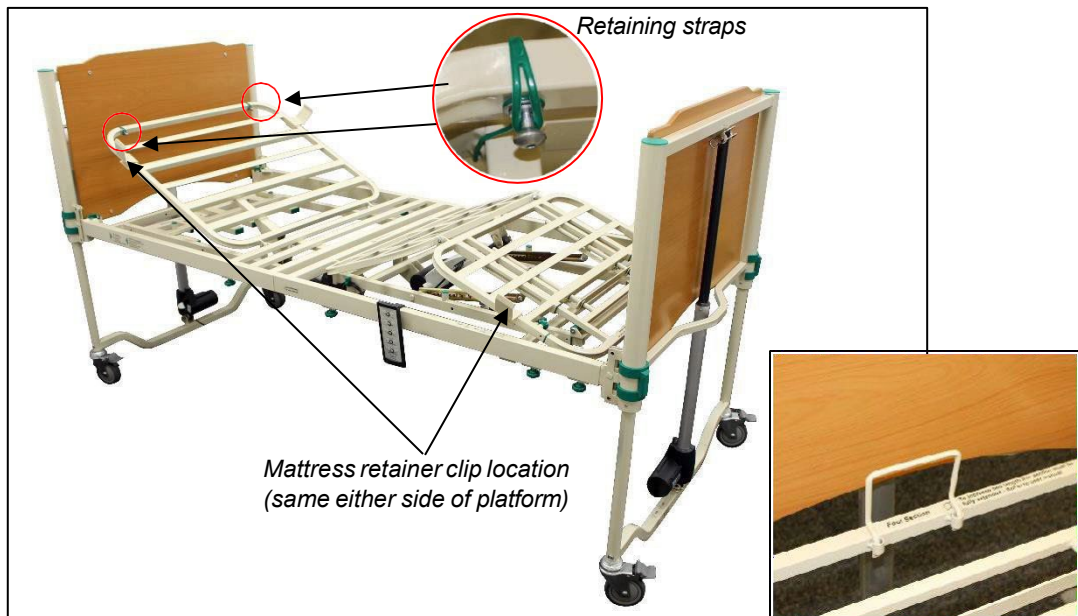
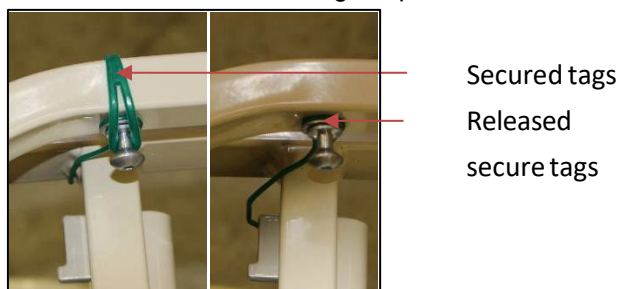

Figure 12: Location of mattress retaining clips and retaining straps

Figure 13. Retainer bar

b. Before using the bed

1. Check all locking collars are locked, i.e. the label is covered.
2. Ensure all securing straps are released.



3. Check all thumb wheels are tight.
4. Are all cables correctly routed and have sufficient slack to allow for movement of the bed?
5. Check there are no obstructions that may affect the bed movement.
6. Apply all the castor brakes.
7. Has a risk assessment been undertaken for the end user? Please refer to 'Example of risk assessment in section 23' of this manual.



Caution: Ensure all cables are not under any undue tension when at their most extended and are free from any moving parts of the bed.

8. Handset Control

Handset Controls are supplied with 10 buttons.



Caution: Ensure that no person, limbs or objects in any way interfere with the desired movement of the bed.

a. 10-button handset

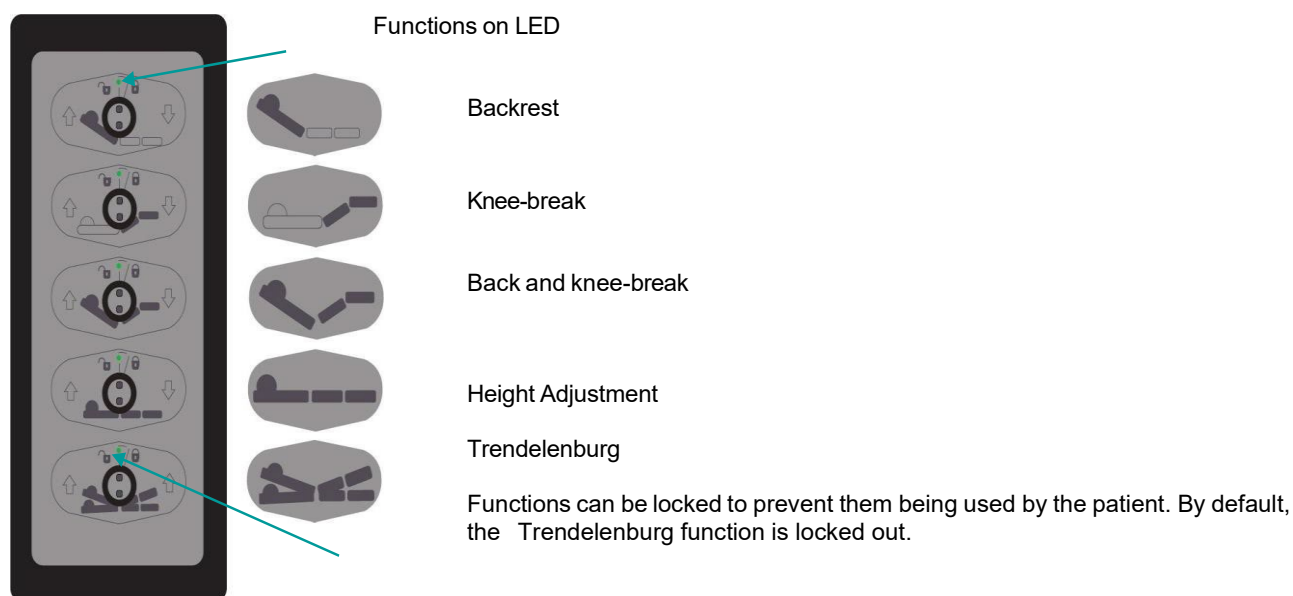

Figure 14: 10-button handset

Functions of the locking device

Each function on the handset can be locked out individually using the key.

- The Trendelenburg and Reverse Trendelenburg functions on the keypad are locked out.
- The handset is provided with a key which enables individual functions on the handset to be locked out so that the patient is only able to use the functions on the bed that have been risk assessed and agreed by clinicians.

Caution: Store the key separately from the handset to avoid accidental activation of unwanted functions.

9. Bed Adjustments

5.2 Knee-break section adjustment



To raise the knee-break section of the bed, press and hold the Up Knee-Break Adjustment Button on the handset to reach the desired position.

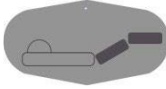

To lower the knee-break section of the bed, press and hold the Down Knee-Break Adjustment Button on the handset to reach the desired position.

5.3 Manual calf section adjustment

The bed is fitted with a manually adjustable calf/leg section. When the knee-break function

on the handset is operated the height or angle of the calf/leg section can be adjusted.

- To decrease the knee break angle, manually raise the calf/leg section to the desired position. The calf/leg section will automatically lock into place (*Figure 15*).
- To lower the calf/leg section (from raised height), fully raise calf/leg section manually and then gently lower it down (*Figure 16*). Then press and hold the Down Knee-Break Adjustment Button on the handset.

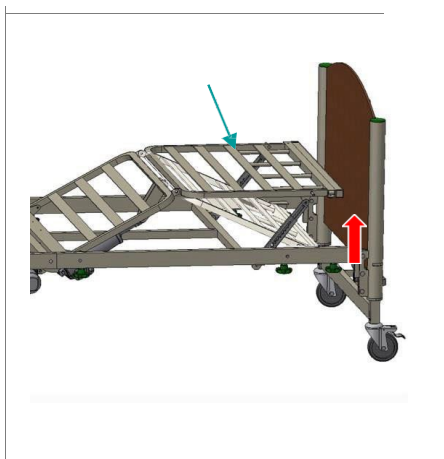

Figure 15: Raising manual calf section

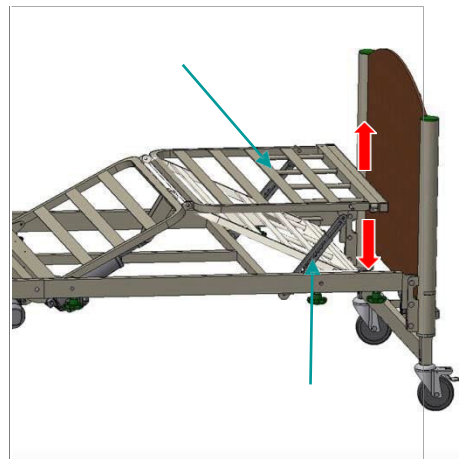

Figure 16: Lowering manual calf section

Caution: Before lowering the knee-break section, ensure that the calf section is set to its lowest position.

a. Backrest section adjustment



To raise the head section press and hold the Up Backrest Adjustment Button on the handset until it reaches the desired height.



To lower press and hold the Down Backrest Adjustment Button on the handset.

b. Bed height adjustment



To raise the height of the bed press and hold the Up Height Adjustment Button on the handset until it reaches the desired height.



To lower press and hold the Down Height Adjustment Button on the handset.



Caution: Before adjusting the height of the bed ensure there is nothing to obstruct the movement of the bed and ensure that no cables will become pinched or be over stretched.

c. Auto-contour adjustment

Auto-contour adjustment allows for the simultaneous adjustment of both the backrest and knee-break sections.



To raise the backrest and knee-break sections of the bed, press and hold the Up Auto-Contour Adjustment Button on the handset to reach the desired position.



To lower the backrest and knee-break sections of the bed, press and hold the Down Auto-Contour Adjustment Button on the handset to reach the desired position.

d. Trendelenburg and Reverse Trendelenburg



To tilt the mattress platform into the head down tilt (Trendelenburg) press and hold the Trendelenburg Adjustment Button.



To tilt the mattress platform into the foot down tilt (Reverse Trendelenburg) press and hold the Reverse Trendelenburg Adjustment Button.

Use of the Trendelenburg or Reverse Trendelenburg function may require the castor brakes to be taken off one end of the bed as this function slightly changes the footprint of the bed. Ensure that the castor brakes are reapplied when the function is no longer required.



Caution: Before carrying out these operations, check there are no objects on or under the lower frame which could interfere with the bed movement. These functions can be locked out by means of the key fob on the handset.

10 Moving the Bed

Before moving the bed, ensure that a risk assessment is completed for the end user. Please refer to 'Example of risk assessment in section 23' of this manual.

To move the bed:

- Disconnect from the mains supply.
- Release all 4 castor brakes, these are foot only operated.
- Move the bed to the desired location.
- Taking care not to run any cables over.
- Re-apply the castor brakes.
- Check there are no obstructions near the bed.
- Check the cabling is not pinched or kinked anywhere.
- Re-connect the bed to the mains supply.



Caution: The bed is only to be moved within the patient room for cleaning or patient access.



Caution: The patient must not be in situ on the bed whilst it is being moved.



Caution: Ensure there is no risk of injury to any person involved in moving the bed and ensure there is no risk of damage to the bed.
Always re assess the risk for the end user for the bed usage with any accessories attached.

11 Selecting a Mattress

Ensure the selection of an appropriate mattress depending on whether the bed is set to standard or extended mode. Having placed the mattress on the bed a risk assessment should be performed to identify potential entrapment risks for the end user. Please refer to 'Example of risk assessment in section 23' of this manual.



Warning: if using side rails, the distance from the top of the uncompressed mattress to the top of the side rail should be more than 220mm.

12 Extending the Bed

The bed can be extended by 200mm. Adjustment is made at the foot end of the bed.

12.1 To extend the bed frame

- Ensure bed frame moving parts are all flat.
- Apply brakes to head end of the bed.
- Loosen the 4 turn hand screws at the foot end of the bed (2 per side)
- Unlock the foot end castors.
- Whilst holding the foot end near the locking collars, pull the bed end out until it reaches the end stops (*Figure 17*).
- Re-tighten all the turn hand screws.

12.2 To extend the platform

- Pull the 'twist and pull locking pins' out on the platform section.
- Slide the platform extension out until it reaches the end stops (*Figure 18*).
- Once the platform extension has been pulled out, pull the 'twist and pull locking pins' out on the 'support extension' below the platform section.
- Slide the support extension out until it reaches the end stops (*Figure 18*).
- Reapply brakes.

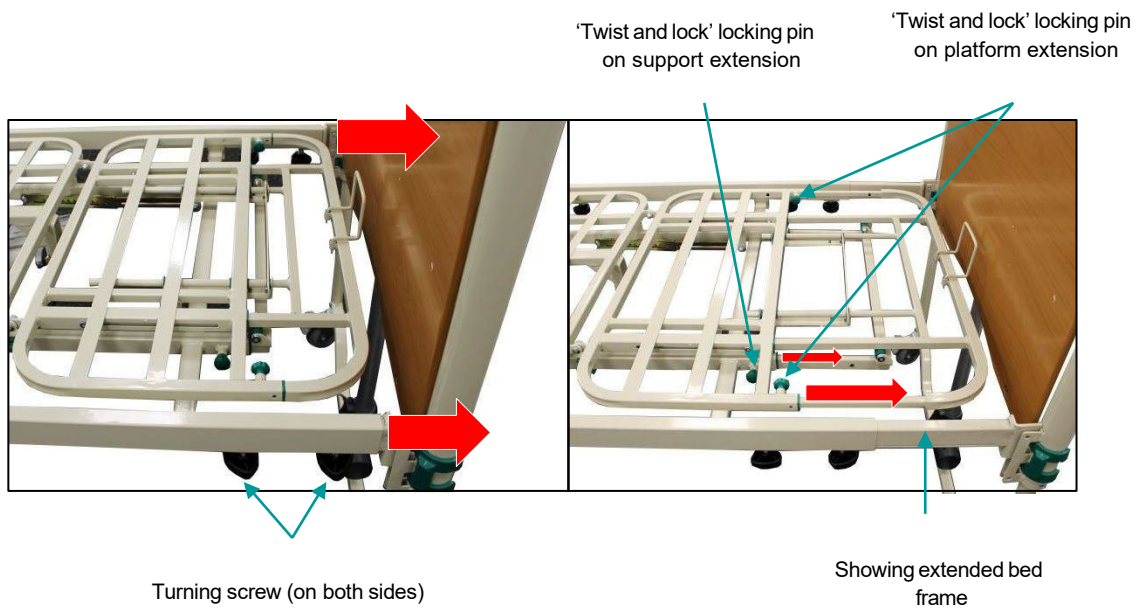

Figure 17: Extending the bed frame

Figure 18: Extending the platform



Caution: Ensure that the mattress platform has been fully extended to bed end before use.

13 Accessories

There are a number of accessories available for the bed provided by Ultimate Healthcare and have been tested with this bed. Please refer to the User Manual for the accessory before using it with the bed. Below is a list of the accessories available for the bed.

Product Code	Description
UBEB7002	¾ length side rails – 4 bar extra high
UBEB7002FL-2	Full Length Rails – Telescopic For Cura II Standard, Extra High and Supreme Beds
UBEB7002FL-3EH	Full Length Extra High Rails – Telescopic For Cura II Standard, Extra High and Supreme Beds
UBEB7003	Patient lifting pole (max load 75kg)
UBEB7004	Grab rail (standard length)
UBEB7004-3	Inline Grab Rail
UBEB002001	Side rail bumpers – standard
UBEB002001FL-2MESH	Netted full length side rail bumpers
UBEB002001FL-2MESH-EXT	Netted full length side rail bumpers extension piece
USPF3408	Mattress squab

All side rails listed above meet the requirements of the MHRA guidelines DB 2006(06) v2.0. It is strongly recommended that these guidelines are read prior to using side rails.



Caution: If any accessories are attached to the bed a full risk assessment must be completed.

- Grab rails (UBEB7004/UBEB7004-3) can be used on both the upper and lower brackets.
- When the bed is on the highest bracket setting all Ultimate Healthcare side rails can be used.
- Full length rails should not be used on the lower bracket setting.
- **Always perform a risk assessment of the bed, mattress and accessories to avoid entrapment.**

13.1 Attaching Grab Rails to the bed

When attaching a Grab Rail, also known as a Bed Stick to the bed the gap between the Grab Rail and the bed end must be less than 60mm or more than 318mm to minimise the risk of entrapment and to comply with entrapment guidance and regulations. Before attaching any Grab Rail to the bed ensure a risk assessment is completed first. Please refer to 'Example of risk assessment in section 23 of this manual.

13.1.1 Attaching the standard grab rail to the bed

1. Unscrew the thumb wheels
2. Attach the grab rail to the bed.
3. Angle the top of the rail forward over the bed and slide the top of the securing clip over the side of the bed platform.
4. Straighten the grab rail to allow the bottom of the clip to slide under the bed platform.
5. The grab rail may be fitted to either end of the bed.
6. When the bed is on the lowest bracket setting, only use, $\frac{3}{4}$ rails and grab handles.
7. **Ensure that the Grab rail is less than 60mm or more than 318mm from the bed end.**
8. Tighten the thumb wheels.
9. Always risk assess for the safety of the end user.



13.1.2 In line Grab Rail



Caution! Remove the nearest mattress retainer before fitting the in line grab rail

1. Fit the in line grab rail as per the instructions above.
2. If using the In-line grab rail in conjunction with side rails ensure a full risk assessment has been undertaken as this will generate entrapment risks. Please refer to 'Example of risk assessment in section 23' of this manual. Using the In-line Grab rail in conjunction with side rails must be agreed with a clinician and risk assessed for the end user.

13.1.3 Daily Checks on Grab Rail



Caution! Risk of entrapment

- The daily maintenance work can be performed by the nursing personnel or carer:
- Check the gap between the bed ends and the grab rail are less than 60mm or greater than 318mm and safe for the end user after risk assessment completed for the beds, mattresses and any accessories to avoid entrapment.
- Check the thumb wheel fastenings are secure.

13.2 Attaching 3/4 Length Side Rails to the bed



When attaching side rails the consideration of safety is paramount. Side rails that have been manufactured by Ultimate Healthcare carrying the product codes UBEB7002 have been

specifically designed for the Cura range of beds; however, you must ensure the following points are adhered to:

1. Position the Side Rails according to the labels on the bed and side rails. Tilt the Side Rail forward and clip over the bed platform, then slide the bottom fixing under the bed platform by straightening up the Side Rail.
2. Ensure that the rails are securely fitted before use. Check the security of the fittings every day.
3. The gap between the side rail and the bed end must be less than 60mm or more than 318mm to minimise **the risk of entrapment** and to comply with entrapment guidance and regulations.
4. When the bed is on the lowest bracket setting, only use, $\frac{3}{4}$ rails and grab handles.
5. **Ensure that the distance from the top of the uncompressed mattress and the top of the side rail is at least 220mm.**

13.3 Attaching Telescopic Length Side Rails to the bed

This User Guide is for the installation of UBEB7002FL-2 & UBEB7002FL-3EH, the full length telescopic side rails; these side rails have been specifically designed for the Cura II, Cura II Extra High, Cura II Supreme and should not be attached to any other bed. The full length side rails are supplied in pairs.

1. Tools required; a set of star / allen / hex keys.
2. Remove the four green caps and bungs from each end post on the bed; store these for replacing when the full length side rails are no longer required.

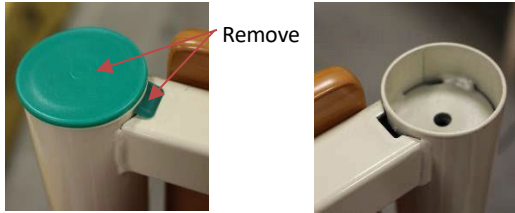

3. Unpack the full length side rails; the end bars are labeled left and right ensure these are connected to the correct side
4. Locate the box of fixings.
5. Place the four green end caps with the hole for the fixing screw (UHSUBEB7-031) into each bed end; replacing the ones that have just been removed.
6. Locate the four larger screws.
7. Attach the appropriate end post to the bed end and tighten with the allen key.



8. Attach the bottom of the sliding bar bracket with 2 smaller screws

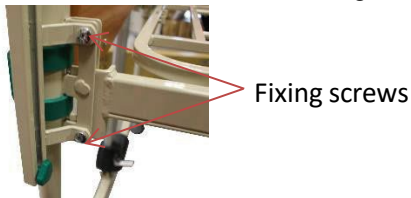

9. Repeat this for all four end posts.
10. Undo and remove the hand screw at the bottom of each fixing channel

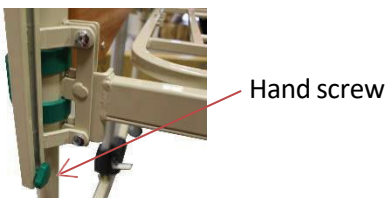

11. The next section is easier if you extend the bed platform slightly, follow the instructions in section 12 earlier in this manual.
12. Undo the green hand screw at the bottom of each fixing channel (4 in total)

13. Ensure the end of fixing wire is secured into the hole shown on the image below.



Fixing wire on side rail

14. Slide the plastic side rail inserts into the inner part of the sliding bar.



Inserting side rail

15. Pull up the side rails until it clicks in place and secure by tightening the green hand screws.

Once all full-length side rails have been attached ensure you test the side rails operate correctly. **Ensure that the distance from the top of the uncompressed mattress and the top of the side rail is at least 220mm.**

Complete Risk assessment to avoid any entrapment of the end user.

13.3.1 Operating the telescopic full length side rails

1. Raise the side rail until each end clips into place.
2. Operate the clip on the side of the sliding bar bracket to lower the side rail. The side rail may need to be raised slightly to operate the clip.

13.3.3 Daily Checks on Side Rails



Caution! Risk of entrapment

- The daily maintenance work can be performed by the nursing personnel or carer:
- Check the bed rails (option) for easy movement and damage.
- Check the correct function of the locking device on the bed rails.
- Check the side rail is fitted according to the labels on the bed and the side rails.
- Check the thumb wheel fastenings are secure.
- When raising and lowering side rails ensure all potential restrictions i.e. bumpers and bed covers are removed
- When raising the rail to its full “in use” height listen for an audible “click”
- Ensure that rail is correctly secured in the “in use” position by applying moderate downward force, if there is excessive movement when raised to the maximum position, **do not use** the rail and report the fault immediately to your supplier.
- Always risk assess for entrapment due to changes in physical and environmental condition of the end user or on position of the bed, mattresses and any accessories attached/moved/removed away from the bed.

13.4 Patient Lifting Pole

1. Insert base section into locating hole at the head end of the bed.
2. Insert the top section of the pole and attach the handle



13.5 Mattress Squab

1. Extend the bed 200mm and insert the Mattress Squab USPF3408 at the head end of the bed.



13.6 Standard Side Rail Bumpers

1. Wrap the side rail bumper UBEB002001 over the side rail and secure the Velcro at the bottom of the side rail. A full length rail bumper UBEB002001FL can also be used on a full length rail.



13.7 Mesh full length side rail bumpers

The fitting instructions are for the installation of UBEB002001FL-2MESH designed to fit the telescopic full length side rails. The mesh side rail bumpers have been specifically designed for the Cura Community, Cura II, Cura II Extra High and Cura II Supreme beds.

1. Remove bed rail bumpers from the packaging and dispose of the packaging safely.
2. Locate the Velcro and make sure it is facing towards the outside of the side rail.
3. Join Velcro strips A and A together over the top side rail and attach along their entire length.
4. Ensure the thicker foam section is attached to the lower rail and the thinner foam to the upper rail.
5. Follow step 3 for Velcro strips B and B on the bottom rail.
6. Ensure that the side rail bumper is securely fixed before use.
7. Periodically check to ensure that the bumper is securely attached to the bed rail to avoid any entrapment.

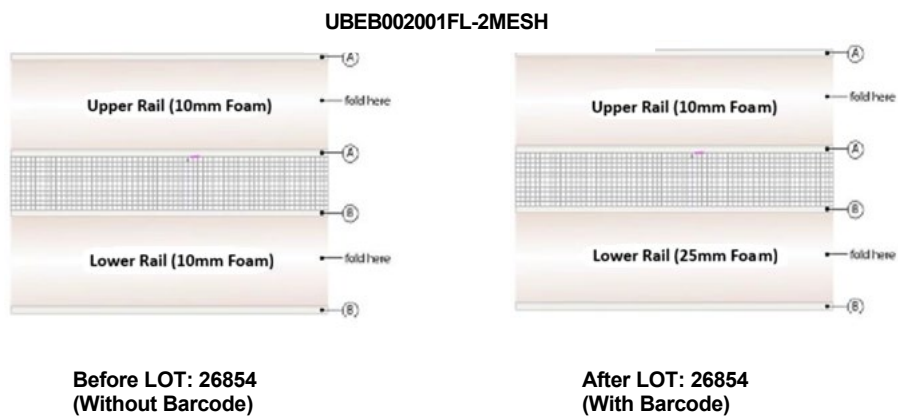

13.8 Attaching full length side rail extension bumpers

8. To add the full length side rail bumper extension, extend the bed and telescopic full length side rail.
9. Join Velcro strips A and A together over the top side rail and attach along their entire length and do the same for Velcro strips B and B on the bottom rail.
10. Ensure the thicker foam section is attached to the lower rail and the thinner foam to the upper rail.'
11. Make sure the extension bumper is placed over the section where the bed extends.

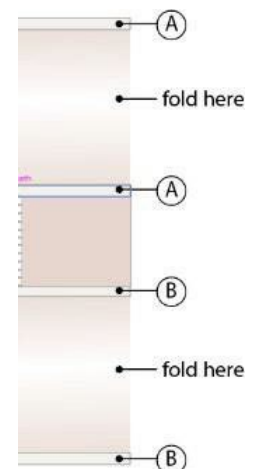

14. Transport and Storage

14.1 Disconnecting the controller

1. Ensure castor brakes are engaged – these are foot operated only.
2. Ensure the mains lead is disconnected before starting to dismantle the bed for transport or storage.
3. Remove the mattress.
4. Remove the connectors from the controller.
5. Remove cables from cabling system where they pass from one side of the bed to the other.

14.2 Dismantling the bed

1. Remove any accessories attached to the bed.
2. If the bed has been extended, return it to the standard length.
3. Apply the castor brakes; this is a foot only operation.
4. Remove the mattress retaining clips.
5. Remove the transport brackets from the bed by unscrewing the hand screws
6. Attach the security tags to the elevating parts of the bed; to avoid entrapment risk.
7. Release the hand screws; if removed store carefully for re-use.
8. Release the castor brakes on one end of the bed only.
9. Carefully slide the two halves of the bed apart and rest them on the floor.
10. Apply the castor brakes; these are foot only operated brakes.
11. Unlock the retaining collars on one end of the bed.
12. Carefully unclip the end of the bed; taking care not to allow it to fall to the floor.
13. Repeat for the other end of the bed.
14. Remove the transport brackets which are secured on the head section of the bed by hand screws.
15. Clip the head and foot end together using the transport bracket which should have the text facing outwards.
16. Turn the locking collars to cover the label, this locks the transport bracket in place.
17. Loosen the hand screws to allow the head and foot sections to slot onto the transport brackets. Place the head end of the bed onto the transport bracket with the motors facing inwards and secure the hand screws.
18. Place the foot end of the bed onto the transport bracket with the motors facing inwards and secure using the Hand screws.
19. Slot the slider on the transport bracket.

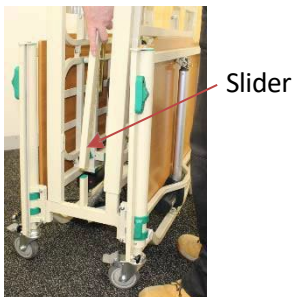

20. Replace the cardboard packaging if retained.

14.3 Storing the bed

When not in use this bed must be stored in a dry, clean environment. We recommend that storage temperatures are between -5°C ~ 40°C and that % Relative Humidity (RH) is between 10~60%.

15. Cleaning and Disinfection



Disconnect the bed from the electricity supply before carrying out decontamination procedures.

15.1 Cleaning

- Please ensure that the power plug is removed from the mains socket prior to attempting any cleaning procedure. This bed is not provided with a mains switch, so the mains plug is the only separation from the mains.
- Clean using damp cloth.
- Only use mild detergents without scouring agents to clean all metal parts and wooden and plastic surfaces.
- Never use sharp edged tools (knives, metal scrapers) or aggressive solvents for cleaning.
- Never use high-pressure cleaners for cleaning.
- Observe the instructions on how to use the detergents in order to avoid damage to the surfaces.
- The bed should be carefully dried after cleaning and before plugging it back in to the mains.

15.2 Disinfection

- Disinfect using a soft cloth.
- Only use normal household disinfectants.
- Do not use harsh, abrasive disinfectant / cleaners.
- Observe the instructions on how to use the disinfectant to avoid damage to the surfaces and to protect your health.

16 Maintenance and Inspection



Hazards due to electrical and mechanical faults!

- Immediately remove faulty/defective medical beds from operation and secure them against unauthorised use (disconnect the mains plug).
- Immediately show any defects to the personnel responsible.
- It is imperative that you always rectify any faults which could influence the function and safety of the nursing bed immediately.
- Observe the safety instructions contained in Section 5.

16.1 Maintenance – daily

- The daily maintenance work can be performed by the nursing personnel or carer
- Lower both bed end actuator motors until they switch off automatically.
- Check the side rails (option) for easy movement and damage.
- Check the correct function of the locking device on the side rails (option).
- All moving parts on this bed are fitted with maintenance-free self-lubricating bearings and should not be oiled or greased.
- Check to ensure that all cables are located safely, not dangling down, and not at risk of being caught in the bed mechanism, by a mobile hoist or any other equipment that may be used under the bed.
- Ensure there is no entrapment risk due to moving or changing of any accessories or end user health condition.

Whenever the bed is moved

- Check the mains cable and plug for damage and kinks.
- Route the mains cable in such a way that it cannot be pinched or rolled over.
- Check to ensure that all cables are located safely, not dangling down, and not at risk of being caught in the bed mechanism, by a mobile hoist or any other equipment that may be used under the bed.
- Always reassess risk of entrapment when bed and or any accessories are moved, changed or if there any changes in end user's health conditions or environment.

17 Trouble Shooting

The table below has been created to assist with resolving faults you may come across; if the instructions here do not resolve the issue or the issue you are experiencing is not listed, please contact your supplier or Ultimate Healthcare using the details found on the back cover of this manual.

Problem	Possible Cause	Resolution
<ul style="list-style-type: none"> No adjustment of the bed can be made when the power is ON 	<ul style="list-style-type: none"> Handset function is locked. 	<ul style="list-style-type: none"> Release the handset function using the key
<ul style="list-style-type: none"> The function shows orange on the handset. 	<ul style="list-style-type: none"> The function is locked out. 	<ul style="list-style-type: none"> Unlock the function if required and try again.
<ul style="list-style-type: none"> The handset doesn't function – 	<ul style="list-style-type: none"> Mains power not connected Handset not connected to the controller 	<ul style="list-style-type: none"> Connect to the mains power Connect the handset to the controller; following the instructions in this manual.
<ul style="list-style-type: none"> When a button is pressed on the handset, the corresponding actuator does not respond 	<ul style="list-style-type: none"> Connectors not plugged into the correct sockets Faulty actuator 	<ul style="list-style-type: none"> Check the connections, are as per the instructions in this user guide Contact your supplier or Ultimate Healthcare using the details on the back cover of this manual
<ul style="list-style-type: none"> An unexpected operation occurs when a button is pressed on the handset 	<ul style="list-style-type: none"> Connectors not plugged into the correct sockets 	<ul style="list-style-type: none"> Check the connections, as per the instructions in this user guide Contact your supplier or Ultimate Healthcare using the details on the back cover of this manual

18 Reuse

The Ultimate Healthcare beds are designed for reuse. They must be cleaned and disinfected prior to reuse as per Section 15.

19 Disposal

Beds consist of:

- Metal parts
- Plastic parts
- Electronic components
- Electric cables
- Rechargeable batteries/batteries

Disposal of the individual materials must be carried out in accordance with the valid regional environmental and disposal regulations.

Beds are not to be disposed of with household waste; they must be taken to local waste collection depots.

Electronic components, electric cable and rechargeable batteries are not to be disposed of with household waste but taken to the stipulated waste disposal depot and disposed of in accordance with the local current regulations.

Note

If you have any questions regarding disposal, please consult your local waste disposal depot or Ultimate Healthcare.

20 Expected Service Life





The expected service life of any medical bed is highly dependent on usage, storage conditions and maintenance regime. Providing that usage is not excessive, that the bed is used and stored in ideal conditions and that the routine maintenance is strictly followed, that any damage is repaired immediately then this bed is expected to have a service life in excess of 5 years.

21 Specifications

21.1 Bed data

Overall length	2185mm
Overall length (extended)	2385mm
Overall width (without side rails)	932mm
Overall width (with removable side rails)	975mm
Overall width (with full length side rails)	1050mm
Mattress platform	2000 x 885mm (2200 x 885 Extended)
Height range	300 – 800 mm
Backrest angle	0-70°
Knee-break angle	0-33°
Calf raise angle	5-20°
Trendelenburg	12°
Reverse Trendelenburg	12°
Safe Working Load (SWL)	250kg / 39.5 stone
Max patient weight	215kg / 34 stone
Total bed weight	83kg
Individual bed section weights:	
Head platform section	20.3kg (Including Actuator) 18.7kg without
Foot platform section	25kg (Including motor and actuator) 22.6kg wo
Bed ends	17.5kg (each)

21.2 Electrical data

	Do not dispose of in household waste
	Voltage type - alternating
	Insulation Class II, Type B
	The patient is not separated from the Ground and the chassis
	For indoor use only
100V - 240V	Voltage supply
50/60Hz	Voltage input frequency
2.5A (control pack) 1A (actuators)	Current drawn by device
Intermittent (periodic motor operation)	Maximum continuous operation of the actuator motors is 2 minutes at maximum load; It must then be followed by a period of rest for 18 minutes, before being activated again.
Max 50dB	Sound Level
IPX6 – Control Pack IPX6–Actuators	Protection type against water Ingress

22 Warranty

Ultimate Healthcare is committed to selling high-quality products. However, for one reason or another there may be a time when you need to exchange or repair a product. Please make sure you check all items carefully on receipt and follow the manufacturer guidelines. It is recommended you keep a receipt or order number to ensure any warranty claim is handled efficiently.

NOTHING IN THIS WARRANTY AFFECTS YOUR STATUTORY RIGHTS

22.1 Product warranty

- Products sold by Ultimate Healthcare (the "Company") are warranted against faulty materials or workmanship under normal use. The Warranty is usually for one year unless otherwise stated.
- For details of the warranty offered for your Product please call our customer services on 0333 321 8996'.

22.2 Conditions of warranty

- Unless otherwise agreed in writing by the Company the Warranty applies to the original registered purchaser of the Product (the "Customer" "you" or "your") and this Warranty only covers defects that occur to the Product during the Warranty Period.
- Defects that occur to the Product during normal usage will, at the sole discretion of the Company, be replaced or repaired free of charge during the Warranty Period [or have parts replaced free of charge], including parts and labor. For the Warranty to be valid the Customer must ensure that:
 - a. The Customer notifies the Company within the Warranty Period of any defect and provides evidence of the date of purchase of the Product, your customer number and the Product Number.
 - b. Unless otherwise agreed the Customer permits the Company onto the Customer's premises to carry out any necessary inspection of the Product(s) and/or repairs.
 - c. All inspections and/or repairs are carried out by the Company or the Company's authorised agent.
 - d. The Product has been used for its intended purpose.
 - e. Repairs to the Product have not been carried out or attempted by the Customer.
 - f. The Product has not been damaged by change, modification or use of the Product, which in the sole judgement of the Company affects the performance, stability or purpose for which it was manufactured.

22.3 The following are excluded from the warranty:

- Repairs due to breakdown caused by use other than domestic by you or your family, or by deliberate damage or neglect of the Products and (where provided) failure to follow the Product care instructions as provided by the Manufacturer or detailed on the Ultimate Healthcare website.
 - a. Cosmetic damage and/or non-functional parts which do not affect the normal use of the Products including but not limited to scratches and rust.
 - b. Damage caused by fair wear and tear.
 - c. Work which relates to a manufacturer's recall of the Products.

- d. Any loss suffered as a result of not being able to use the Product, or any loss other than the repair or the replacement cost of the Product.
- Before agreeing to replace or repair your Product under this Warranty the Company reserves the right to request that it is returned to the Company.
- The Company regrets that when repairing or replacing your Product under this Warranty the Company must reserve the right to use alternative specifications or materials, which may not match other items in a set.
- The Company reserves the right to charge for the expense of visiting you when no fault has been found with the Product after the Company has inspected it.

22.4 How to make a claim

If you wish to make a claim under the Product Warranty please contact the Company on **0333 321 8996**; e-mail us at: enquiries@ultimatehealthcare.co.uk or contact us by post at Ultimate Healthcare. Calmore Industrial Park, Nutsey Lane, Totton, Hampshire, SO40 3XJ, giving full details of the defect, your name, address and the date you purchased the Product. You are required to provide proof of the date you purchased the Product.

- a. The Company will discuss with you whether a repair or replacement will be offered. The option of a repair or replacement is at the Company's sole discretion.
- b. Where a repair to the Product is agreed the Company will decide at their sole discretion whether the required repair work will be carried out at your premises or at the Company's premises.
- c. Where the Product is to be repaired at the Company's premises provided you live within mainland United Kingdom, the Company will collect your Product from you and return it to you once it is repaired free of charge.
- d. Where your Product is to be replaced, provided you live within mainland United Kingdom, the Company will deliver a new Product to you free of charge.
- e. If you live outside mainland United Kingdom, you will be required to pay a delivery charge for the collection, and/or delivery of your Product.

22.5 General

- a. This Warranty applies to the original registered purchaser of the Product only and may not be transferred.
- b. This Warranty will be governed by English Law.

23 Example of risk assessment

This is an example of a basic risk assessment of a bed rail installation for an adult. It should not be adopted or used without adequate consideration of a specific bed occupant's needs and local policies and may need to be preceded by an assessment of whether rails are necessary at all. A separate checklist would be necessary for a child or very small adult user.

The checklist should be used in conjunction with the guidance in this document, together with the judgement of the nurse, therapist, user and carer involved.

Is the bed rail to be used with an adult-sized user (i.e. a patient taller than 1.46m/4'11")?	<input type="checkbox"/> Yes <input type="checkbox"/> No
Has the bed rail been inspected and maintained regularly, if previously used?	<input type="checkbox"/> Yes <input type="checkbox"/> No
Does the manufacturer/supplier provide any information on special considerations or contra-indications?	<input type="checkbox"/> Yes <input type="checkbox"/> No
Do you have enough information from the supplier to be able to select and fit the bed rail appropriately?	<input type="checkbox"/> Yes <input type="checkbox"/> No
Is the bed rail suitable for the intended bed, according to the supplier's instructions?	<input type="checkbox"/> Yes <input type="checkbox"/> No
Do the fittings or mattress allow the bed rail to be fitted to the bed securely, so that there is no excessive movement?	<input type="checkbox"/> Yes <input type="checkbox"/> No
Does the benefit of any special or extra mattress outweigh any increased entrapment risk by the bed rails created by extra compression at the mattress edge?	<input type="checkbox"/> Yes <input type="checkbox"/> No
Does the bed rail height take into account any increased mattress thickness or additional overlay?	<input type="checkbox"/> Yes <input type="checkbox"/> No
<p>Have you made sure that there are no gaps present that could present an entrapment risk to any part of patient's body?</p> <ul style="list-style-type: none"> • between the bars of the bed rails? 120 mm max • through any gap between the bed rail / Grab Handle/ bed levers/ bed sticks and side of the mattress? • through the gap between the lower bed rail bar and the mattress platform, allowing for compression of the mattress at its edge? 	<input type="checkbox"/> Yes <input type="checkbox"/> No <input type="checkbox"/> Yes <input type="checkbox"/> No <input type="checkbox"/> Yes <input type="checkbox"/> No
Is the headboard to bed rail end gap appropriate?	<input type="checkbox"/> Yes <input type="checkbox"/> No

'Yes' boxes indicate the desired outcome. If any 'No' box has been ticked, there may be a serious risk of entrapment with the proposed combination. Review immediately.

Risk assessments for any entrapment should be carried out before use and then reviewed and recorded after each significant change in the bed occupant's condition, replacement of any part of the equipment combination and regularly during its period of use, according to local policy.

INTENTIONALLY LEFT BLANK

Ultimate Healthcare Ltd

Calmore Industrial Estate, Nutsey lane, Totton

Southampton, Hampshire, SO40 3XJ

Tel: 0333 321 8996

Email: enquiries@ultimatehealthcare.co.uk

www.ultimatehealthcare.co.uk

